

Features

- N and P-Channel
- Trench Technology Power MOSFET
- Low Gate Charge and $R_{DS(ON)}$
- Low Gate Resistance
- 100% EAS Tested

V_{DS}	40	-40	V
$R_{DS(on),TYP}@ V_{GS}=\pm 10V$	13	32	m Ω
$R_{DS(on),TYP}@ V_{GS}=\pm 4.5V$	18	43	m Ω
I_D	21	-18	A

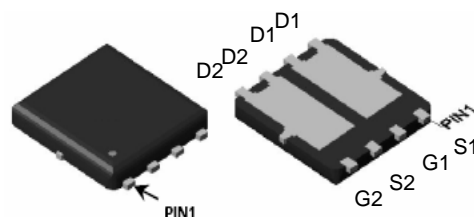

Part ID	Package Type	Marking	Packing
ZT20W04G	DFN5x6	ZT20W04G	5000pcs/Reel

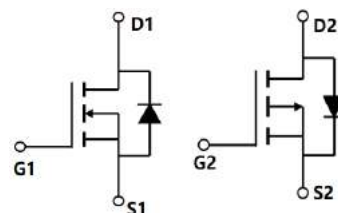

Absolute Maximum Ratings $T_A = 25^\circ\text{C}$, unless otherwise specified

Symbol	Parameter	N-Ch	P-Ch	Unit	
Common Ratings ($T_C=25^\circ\text{C}$ Unless Otherwise Noted)					
V_{GS}	Gate-Source Voltage	± 20	± 20	V	
$V_{(BR)DSS}$	Drain-Source Breakdown Voltage	40	-40	V	
T_J	Maximum Junction Temperature	150	150	$^\circ\text{C}$	
T_{STG}	Storage Temperature Range	-55 to 150	-55 to 150	$^\circ\text{C}$	
I_{DM}	Drain Current-Continuous@ Current-Pulsed (Note 2)	$T_C = 25^\circ\text{C}$	36	-32	A
Mounted on Large Heat Sink					
I_D	Drain Current-Continuous (Note 2)	$T_C = 25^\circ\text{C}$	21	-18	A
		$T_C = 100^\circ\text{C}$	17	-15	A
P_D	Maximum Power Dissipation (Note 4)	24	31	W	
$R_{\theta JC}$	Thermal Resistance-Junction to Case (Note 1)	5	5	$^\circ\text{C/W}$	
$R_{\theta JA}$	Thermal Resistance Junction-Ambient (Note 1)	61	61	$^\circ\text{C/W}$	
Drain-Source Avalanche Ratings					
EAS	Avalanche Energy, Single Pulsed (Note 3)	71	71	mJ	

Electrical Characteristics (T_J=25°C unless otherwise noted) N channel

Symbol	Parameter	Condition	Min	Typ	Max	Unit
Static Electrical Characteristics @ T_J=25°C (unless otherwise stated)						
V(BR)DSS	Drain-Source Breakdown Voltage	V _{GS} =0V, I _D =250μA	40	--	--	V
I _{DSS}	Zero Gate Voltage Drain Current	V _{DS} =32V, V _{GS} =0V	--	--	1	μA
I _{GSS}	Gate-Body Leakage Current	V _{GS} =±20V, V _{DS} =0V	--	--	±100	nA
V _{GS(th)}	Gate Threshold Voltage	V _{DS} =V _{GS} , I _D =250μA	1.0	1.5	2.0	V
R _{DS(on)}	Drain-Source On-State Resistance ^(Note 2)	V _{GS} =10V, I _D =10A	--	13	17	mΩ
R _{DS(on)}	Drain-Source On-State Resistance	V _{GS} =4.5V, I _D =5A	--	18	22	mΩ
g _{FS}	Forward Transconductance	V _{DS} =5V, I _D =15A	--	33	--	S
Dynamic Electrical Characteristics @ T_J = 25°C (unless otherwise stated)						
C _{iss}	Input Capacitance	V _{DS} =15V, V _{GS} =0V, f=1MHz	--	1108	--	pF
C _{oss}	Output Capacitance		--	112	--	pF
C _{rss}	Reverse Transfer Capacitance		--	79	--	pF
R _g	Gate Resistance	f=1MHz	--	2.3	--	Ω
Q _g	Total Gate Charge	V _{DS} =32V, I _D =15A, V _{GS} =4.5V	--	11	--	nC
Q _{gs}	Gate-Source Charge		--	2.6	--	nC
Q _{gd}	Gate-Drain Charge		--	4.7	--	nC
Switching Characteristics						
T _{d(on)}	Turn-on Delay Time	V _{DD} =20V, I _D =15A, R _G =3.3Ω, V _{GS} =10V	--	2.6	--	ns
T _r	Turn-on Rise Time		--	13	--	ns
T _{d(off)}	Turn-Off Delay Time		--	19	--	ns
T _f	Turn-Off Fall Time		--	6.1	--	ns
Source- Drain Diode Characteristics @ T_J = 25°C (unless otherwise stated)						
I _{SD}	Source-Drain Current (Body Diode) ^(Note 1,5)	V _G =V _D =0V	--	--	21	A
V _{SD}	Forward on voltage ^(Note 2)	I _S =1A, V _{GS} =0V	--	--	1.2	V
T _{rr}	Reverse Recovery Time	T _J =25°C, I _F =15A,	--	10	--	ns
Q _{rr}	Reverse Recovery Charge	di/dt=100A/μs	--	3.0	--	nC

Note :

- 1、The data tested by surface mounted on a 1 inch² FR-4 board with 2OZ copper.
- 2、The data tested by pulsed , pulse width ≦ 300us , duty cycle ≦ 2%
- 3、The EAS data shows Max. rating . The test condition is V_{DD}=25V, V_{GS}=10V, L=0.1mH, I_{AS}=10A
- 4、The power dissipation is limited by 150°C junction temperature
- 5、The data is theoretically the same as I_D and I_{DM} , in real applications , should be limited by total power dissipation.

Electrical Characteristics (T_J=25°C unless otherwise noted) P channel

Symbol	Parameter	Condition	Min	Typ	Max	Unit
Static Electrical Characteristics @ T_J=25°C (unless otherwise stated)						
V(BR)DSS	Drain-Source Breakdown Voltage	V _{GS} =0V, I _D =-250μA	-40	-46	--	V
I _{DSS}	Zero Gate Voltage Drain Current	V _{DS} =-32V, V _{GS} =0V	--	--	-1	μA
I _{GSS}	Gate-Body Leakage Current	V _{GS} =±20V, V _{DS} =0V	--	--	±100	nA
V _{GS(th)}	Gate Threshold Voltage	V _{DS} =V _{GS} , I _D =-250μA	-1.1	-1.7	-2.5	V
R _{DS(on)}	Drain-Source On-State Resistance	V _{GS} =-10V, I _D =-10A	--	32	39	mΩ
R _{DS(on)}	Drain-Source On-State Resistance	V _{GS} =-4.5V, I _D =-5A	--	43	53	mΩ
g _{FS}	Forward Transconductance	V _{DS} =-5V, I _D =-8A	--	12.3	--	S
Dynamic Electrical Characteristics @ T_J = 25°C (unless otherwise stated)						
C _{iss}	Input Capacitance	V _{DS} =-15V, V _{GS} =0V, f=1MHz	--	1117	--	pF
C _{oss}	Output Capacitance		--	121	--	pF
C _{rss}	Reverse Transfer Capacitance		--	79	--	pF
R _g	Gate Resistance	f=1MHz	--	14	--	Ω
Q _g	Total Gate Charge	V _{DS} =-20V, I _D =-12A, V _{GS} =-4.5V	--	9	--	nC
Q _{gs}	Gate-Source Charge		--	2.6	--	nC
Q _{gd}	Gate-Drain Charge		--	3.2	--	nC
Switching Characteristics						
T _{d(on)}	Turn-on Delay Time	V _{DD} =-15V, I _D =-1A, R _G =3.3Ω, V _{GS} =-10V	--	18	--	ns
T _r	Turn-on Rise Time		--	13	--	ns
T _{d(off)}	Turn-Off Delay Time		--	49	--	ns
T _f	Turn-Off Fall Time		--	4.5	--	ns
Source- Drain Diode Characteristics @ T_J = 25°C (unless otherwise stated)						
I _{SD}	Source-Drain Current (Body Diode)		--	--	-18	A
V _{SD}	Forward on voltage (Note 2)	I _S = -1A, V _{GS} =0V	--	--	-1.0	V
T _{rr}	Reverse Recovery Time	T _J =25°C, I _F = 15A,	--	10	--	nS
Q _{rr}	Reverse Recovery Charge	di/dt=100A/μs	--	3.0	--	nC

Note :

- The data tested by surface mounted on a 1 inch² FR-4 board with 2OZ copper.
- The data tested by pulsed , pulse width ≤ 300us , duty cycle ≤ 2%
- The EAS data shows Max. rating . The test condition is V^{DD}=-25V, V^{GS}=-10V, L=0.1mH, I^{AS}=-10A
- The power dissipation is limited by 150°C junction temperature
- The data is theoretically the same as I_D and I_{DM} , in real applications , should be limited by total power dissipation.

N-Typical Characteristics

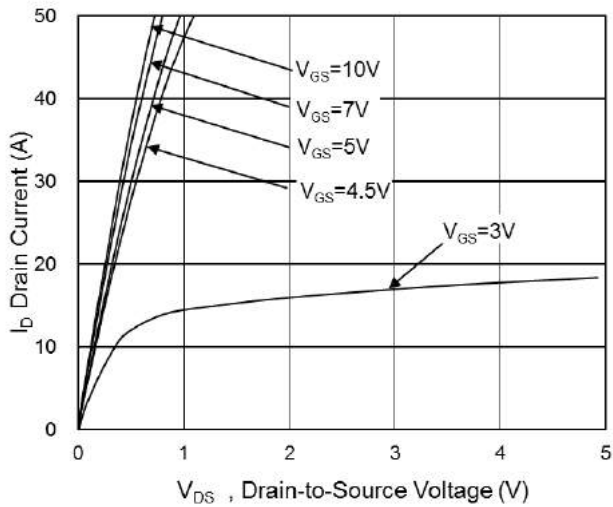

Fig.1 Typical Output Characteristics

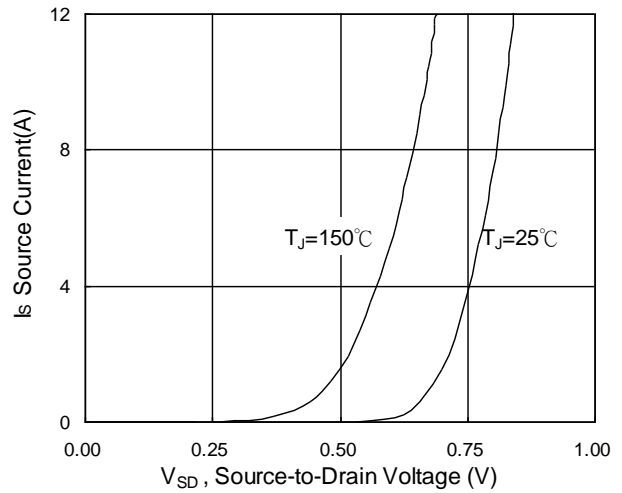

Fig.4 Forward Characteristics of Reverse

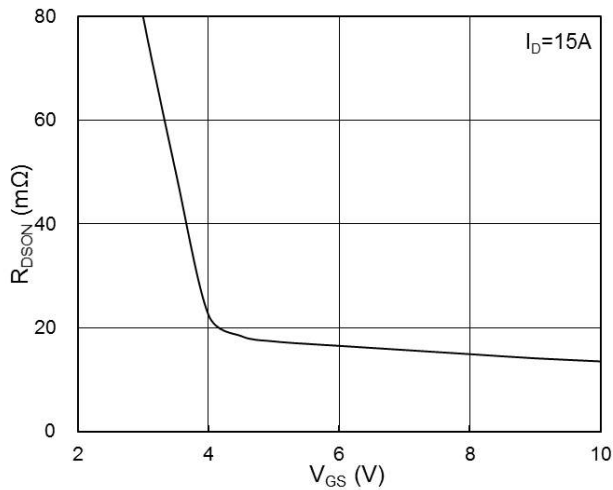

Fig.2 On-Resistance vs. G-S Voltage

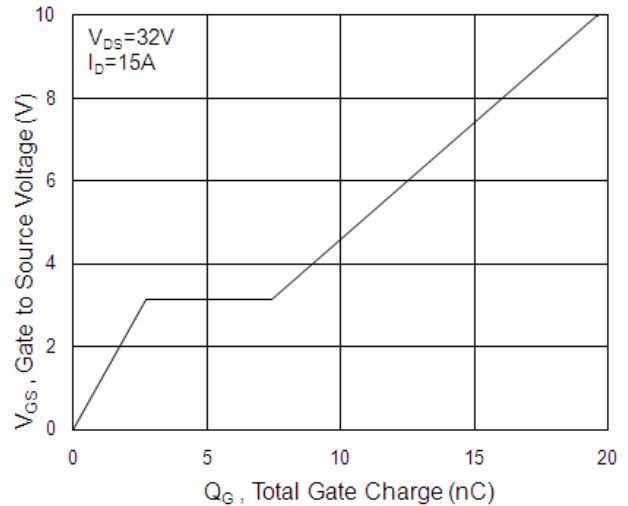

Fig.5 Gate-Charge Characteristics

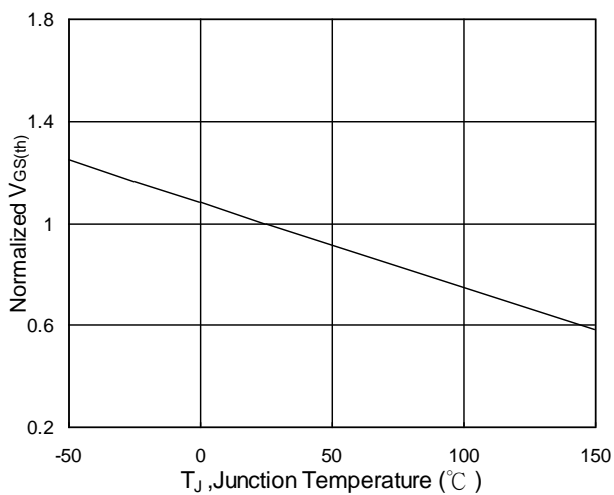

Fig.3 Normalized $V_{GS(th)}$ vs. T_J

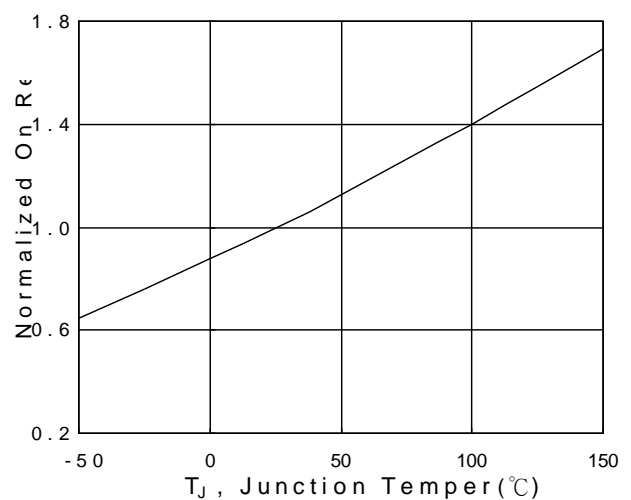

Fig.6 Normalized $R_{DS(on)}$ vs. T_J

N-Typical Characteristics

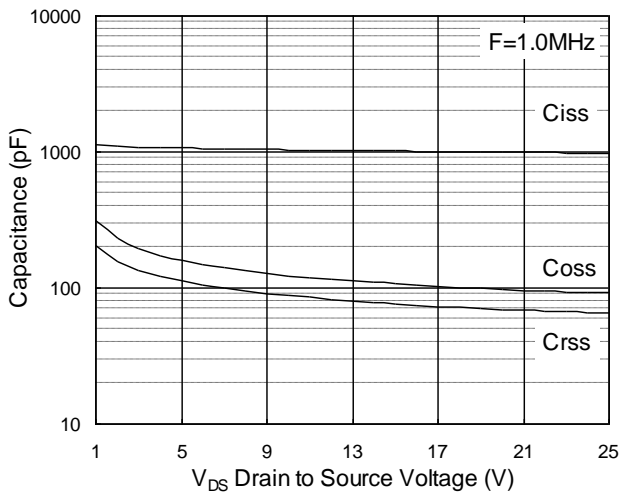

Fig.7 Capacitance

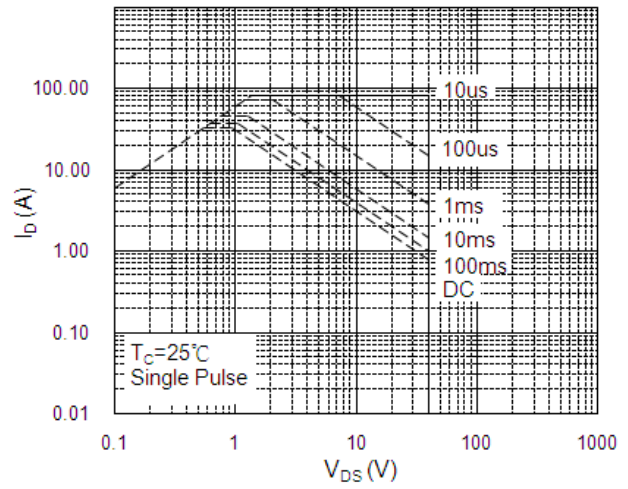

Fig.8 Safe Operating Area

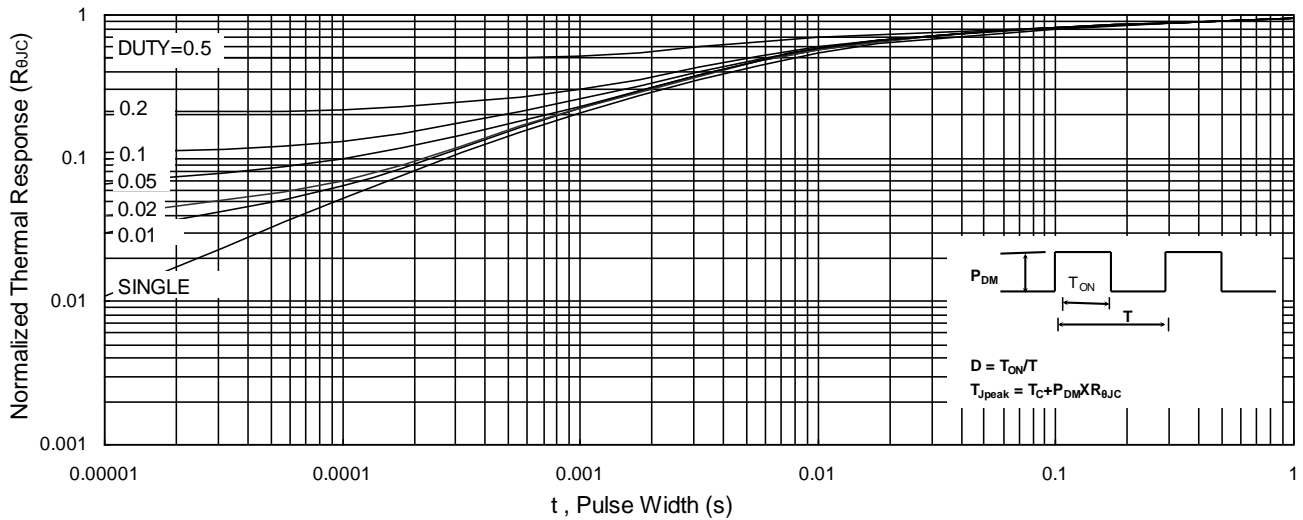

Fig.9 Normalized Maximum Transient Thermal Impedance

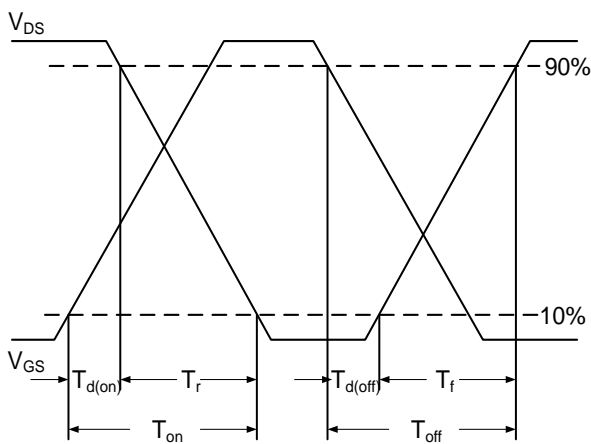

Fig.10 Switching Time Waveform

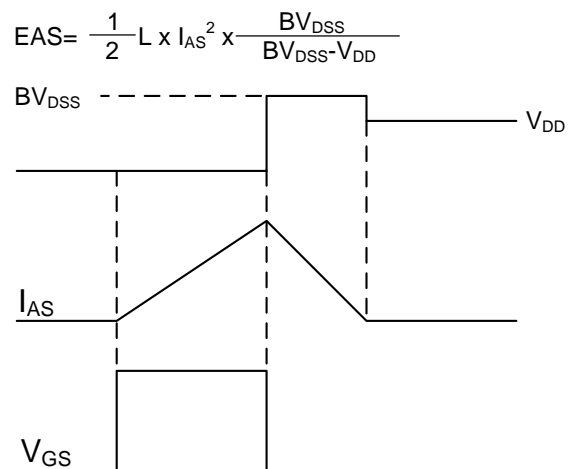

Fig.11 Unclamped Inductive Switching Waveform

P-Typical Characteristics

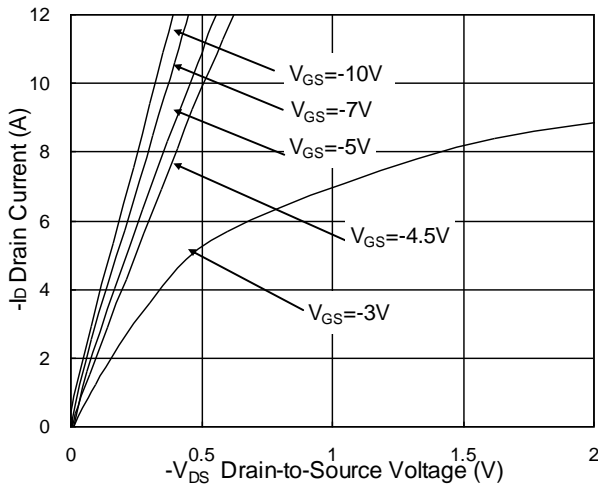

Fig.1 Typical Output Characteristics

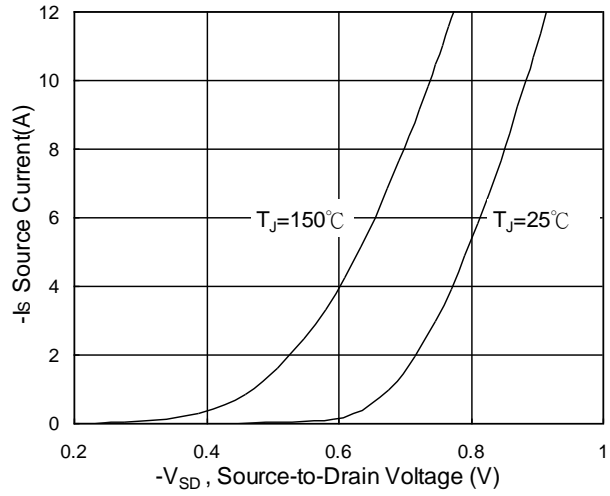

Fig.4 Forward Characteristics of Reverse

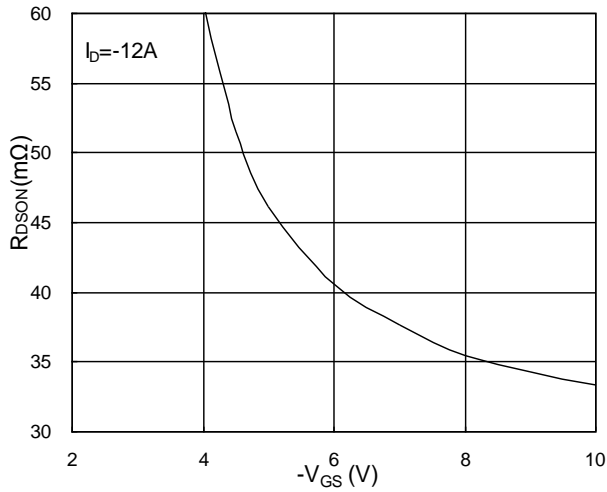

Fig.2 On-Resistance v.s Gate-Source

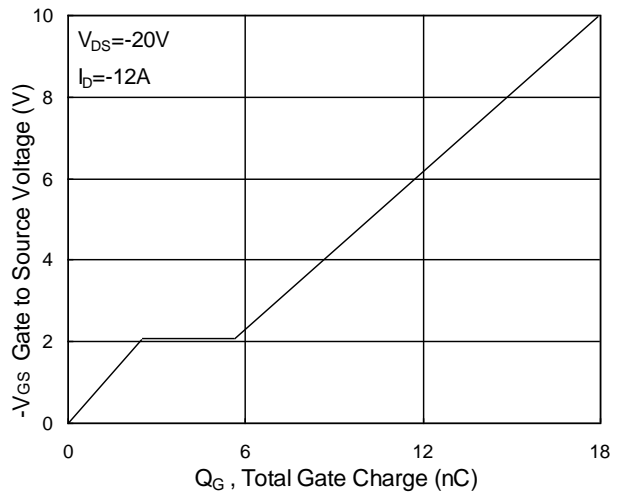

Fig.5 Gate-Charge Characteristics

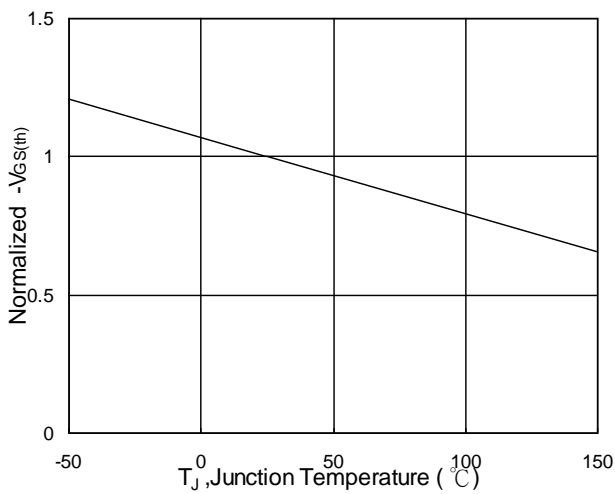

Fig.3 Normalized $V_{GS(th)}$ v.s T_J

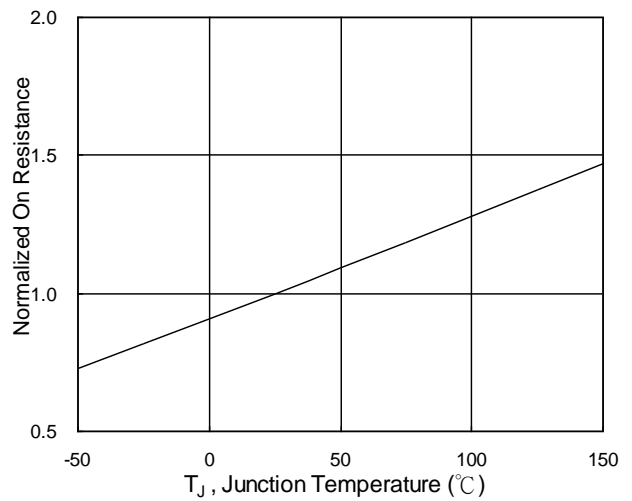

Fig.6 Normalized $R_{DS(on)}$ v.s T_J

P-Typical Characteristics

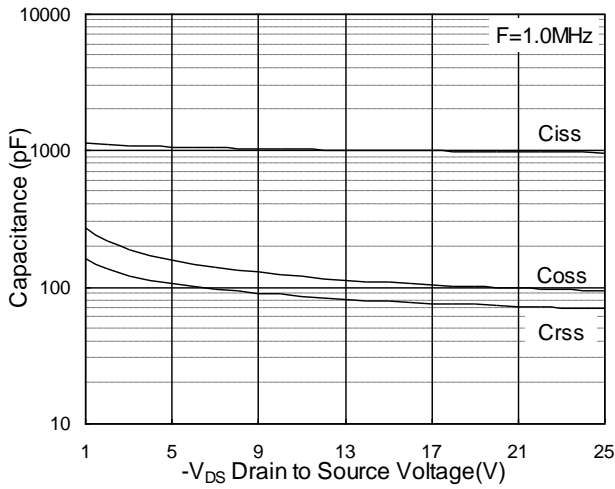

Fig.7 Capacitance

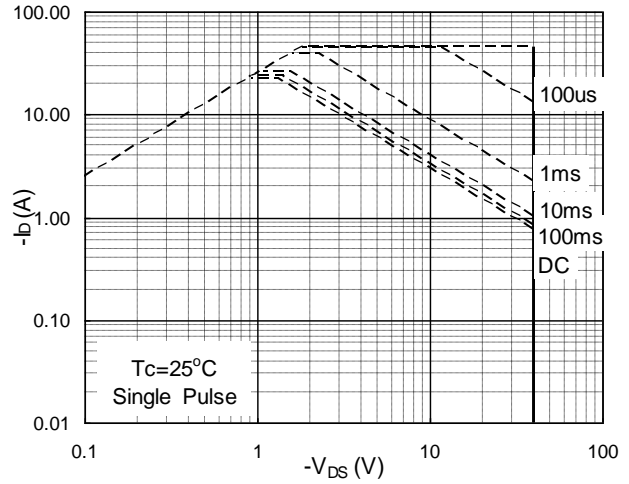

Fig.8 Safe Operating Area

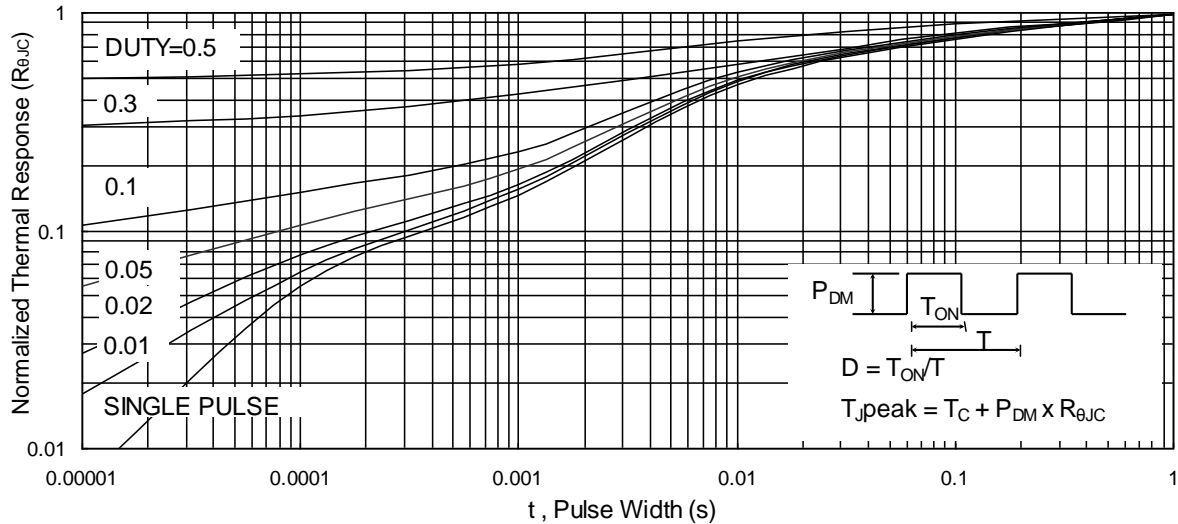

Fig.9 Normalized Maximum Transient Thermal Impedance

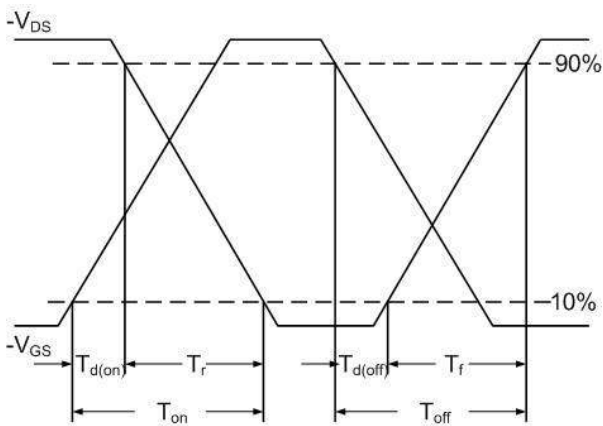

Fig.10 Switching Time Waveform

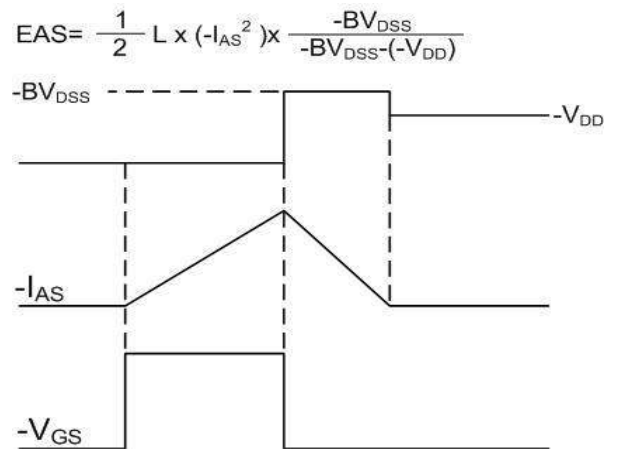
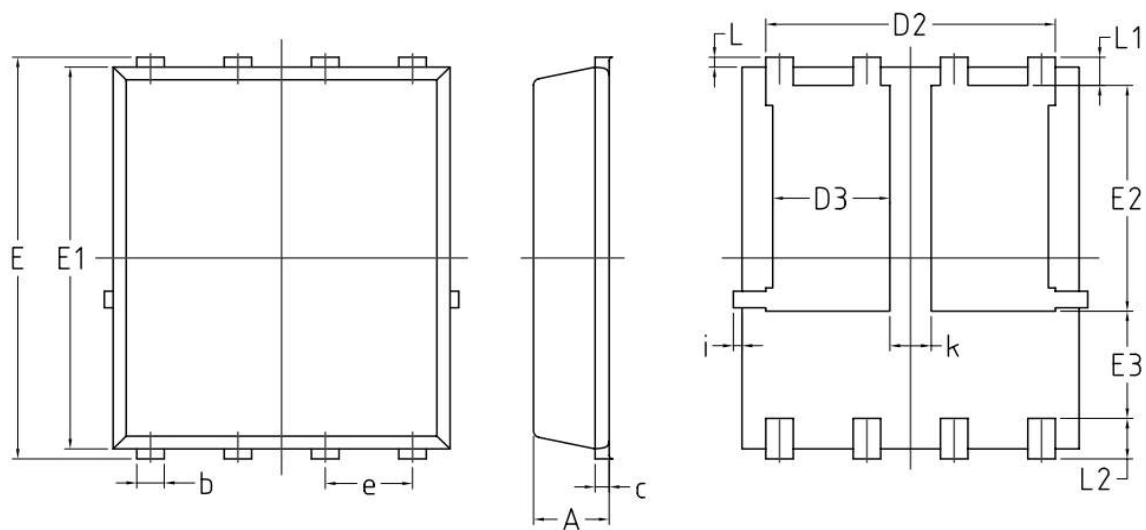

Fig.11 Unclamped Inductive Waveform

DFN5x6-8L Package Information



SYMBOL	COMMON			
	MM		INCH	
	MIN.	MAX.	MIN.	MAX.
A	1.03	1.17	0.0406	0.0461
b	0.34	0.48	0.0134	0.0189
c	0.203 BSC		0.0080 BSC	
D	4.80	5.40	0.1890	0.2126
D1	4.80	5.00	0.1890	0.1969
D2	4.11	4.31	0.1620	0.1700
D3	1.60	1.80	0.0629	0.0708
E	5.95	6.15	0.2343	0.2421
E1	5.65	5.85	0.2224	0.2303
E2	3.30	3.50	0.1300	0.1378
E3	1.40	/	0.0551	/
e	1.27 BSC		0.05 BSC	
L	0.05	0.25	0.0019	0.0098
L1	0.38	0.50	0.0150	0.0197
L2	0.38	0.71	0.0150	0.0280
i	/	0.18	/	0.0070
k	0.5	0.7	0.0197	0.0276

Customer Service

Sales and Service:

zj@ztasemi.com